

14

13

12

C

DRAWING NO.

27L6082

REV

1

SHEET

1

## RBC PROPRIETARY AND CONFIDENTIAL INFORMATION

This document is the property of REGAL BELOIT CORPORATION ("RBC") including its subsidiaries and divisions and contains proprietary information of RBC. This document is loaned on the express condition that neither it nor the information contained hereon be disclosed to others without the express written consent of RBC, and that the information shall be used by the recipient only as approved expressly by RBC. This document shall be returned to RBC upon request. This document may be subject to certain restrictions under U.S. export control laws and regulations.

## REVISIONS

REV.	DESCRIPTION	DATE	APPROVED
1	Modified per ECN NO. 0627.	11/11/05	HV

3.66±.06

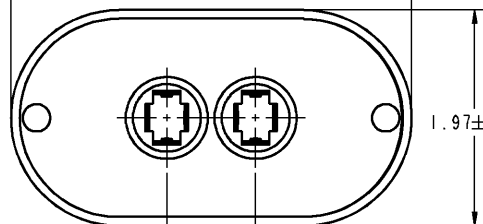

1.97±.06

0.81±.03

Ø 0.75±.03

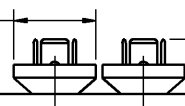

0.52 Max.

4.75±.06

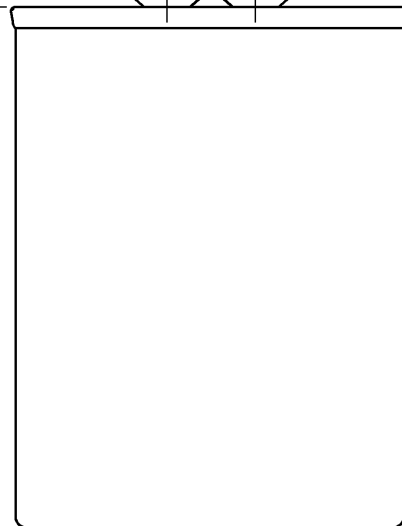

1.86±.04

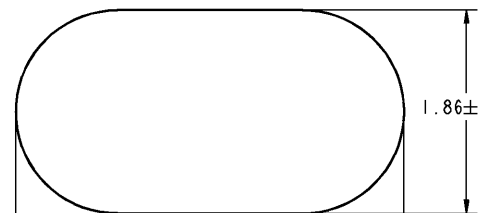

3.54±.04

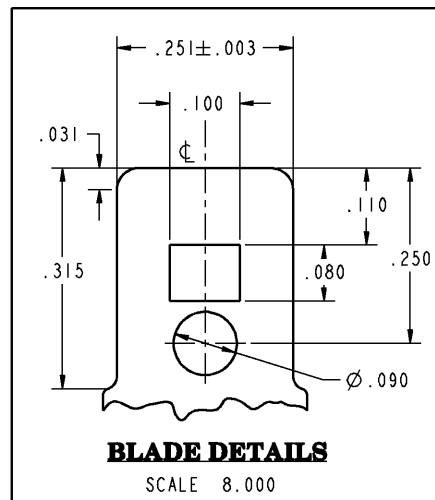
**BLADE DETAILS**

SCALE 8.000

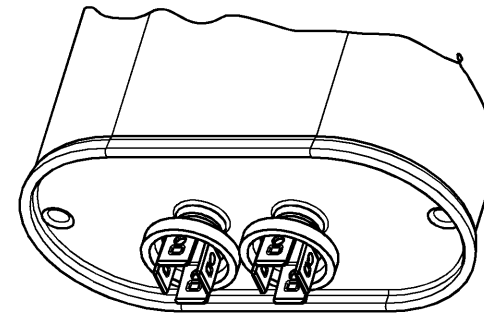

SCALE 1.500

**SPECIFICATIONS :**

"GEM-III Capacitors are manufactured with High Grade Metallized Polypropylene Film"

Main Capacitance	: 20.00µF ±6%
Secondary Capacitance	: NIL
Volts	:660AC
Leakage Current	:30µA Max.
Frequency	:50/60 HZ
Operating Temperature	: -40 DEG C TO 70 DEG C
Storage Temperature	: -40 DEG C TO 90 DEG C
Operative Life	:60,000 HRS WITH 94% SURVIVAL
Dissipation Factor	:0.1% MAX.
Case Material	:ALUMINIUM
Cover Material	:TERNPLATE
Terminals	: 0.250"x0.031" Quick Connect Blades
Dielectric Fluid	:DIELEKTROL VI
Internal Protection	: UL RECOGNIZED PRESSURE SENSITIVE INTERRUPTER

THIRD ANGLE PROJECTION

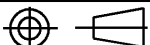

FOR ADDITIONAL INFO REFER TO:	SIGNATURES	DATE
APPLIED PRACTICES	MODEL RAGHU.P.H	05/16/03
UNLESS OTHERWISE SPECIFIED DIMENSIONS ARE IN INCHES	DETAIL RAGHU.P.H	05/16/03
TOLERANCE ON:	CHECKED RAGHU.P.H	05/21/03
1 PL DECIMALS ± 0.1	ENGRG	-
2 PL DECIMALS ± 0.01	MFG	-
3 PL DECIMALS ± 0.001	QUALITY	-
ANGLES ± 0.5	ISSUED	-
FRACTIONS ±		
FINISH		



REGAL-BELOIT CORPORATION

TITLE

**GEM III CAPACITOR  
OUTLINE DRAWING**

SIZE

DRAWING

C

27L6082

REV

1

SCALE: 1.250

REF. No. :

SHEET 1 OF 1

14

13

12

11